

## SOT-89 Plastic-Encapsulate Transistors

### FEATURES

- Low Collector-Emitter Saturation Voltage
- High Breakdown Voltage
- TRANSISTOR (NPN)

### MECHANICAL DATA

- Case style:SOT-89 -3L molded plastic
- Mounting position:any

### SOT-89-3L

Unit:mm

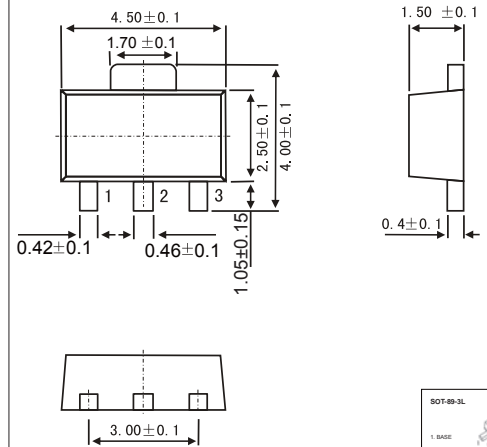

## MAXIMUM RATINGS AND CHARACTERISTICS

@ 25°C Ambient Temperature (unless otherwise noted)

Symbol	Parameter	Value	Unit
$V_{CBO}$	Collector-Base Voltage	310	V
$V_{CEO}$	Collector-Emitter Voltage	305	V
$V_{EBO}$	Emitter-Base Voltage	5	V
$I_C$	Collector Current -Continuous	200	mA
$I_{CM}$	Collector Current -Pulsed	500	mA
$P_C$	Collector Power Dissipation	500	mW
$R_{\theta JA}$	Thermal Resistance from Junction to Ambient	250	°C/W
$T_J$	Junction Temperature	150	°C
$T_{stg}$	Storage Temperature	-55~+150	°C

### PACKAGE INFORMATION

Device	Package	Shipping
A42	SOT-89	1000/Tape&Reel

Parameter	Symbol	Test conditions	Min	Typ	Max	Unit
Collector-base breakdown voltage	$V_{(BR)CBO}$	$I_C=100\mu A, I_E=0$	310			V
Collector-emitter breakdown voltage	$V_{(BR)CEO}$	$I_C=1mA, I_B=0$	305			V
Emitter-base breakdown voltage	$V_{(BR)EBO}$	$I_E=100\mu A, I_C=0$	5			V
Collector cut-off current	$I_{CBO}$	$V_{CB}=200V, I_E=0$			0.25	$\mu A$
	$I_{CEX}$	$V_{CE}=100V, V_X=5V$			5	$\mu A$
		$V_{CE}=300V, V_X=5V$			10	$\mu A$
Emitter cut-off current	$I_{EBO}$	$V_{EB}=5V, I_C=0$			0.1	$\mu A$
DC current gain	$h_{FE(1)}$	$V_{CE}=10V, I_C=1mA$	60			
	$h_{FE(2)}$	$V_{CE}=10V, I_C=10mA$	100		300	
	$h_{FE(3)}$	$V_{CE}=10V, I_C=30mA$	75			
Collector-emitter saturation voltage	$V_{CE(sat)}$	$I_C=20mA, I_B=2mA$			0.2	V
Base-emitter saturation voltage	$V_{BE(sat)}$	$I_C=20mA, I_B=2mA$			0.9	V
Transition frequency	$f_T$	$V_{CE}=20V, I_C=10mA, f=30MHz$	50			MHz

### ■ Marking

Marking	A42
---------	-----

# RATINGS AND CHARACTERISTIC CURVES

## ■ Typical Characteristics

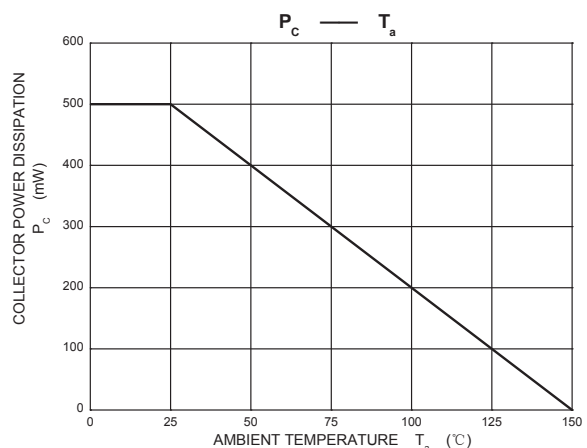
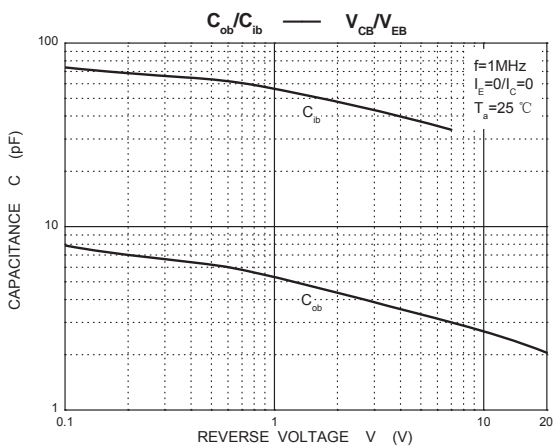
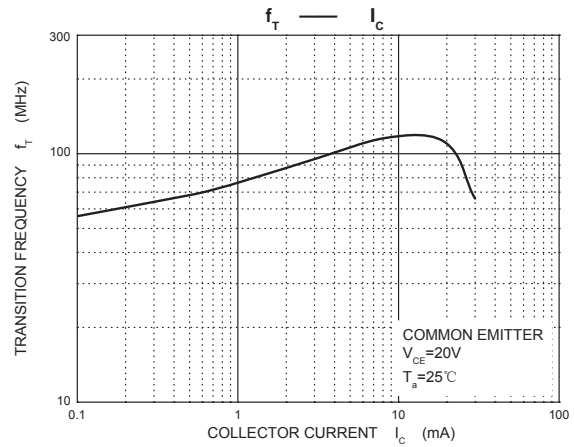
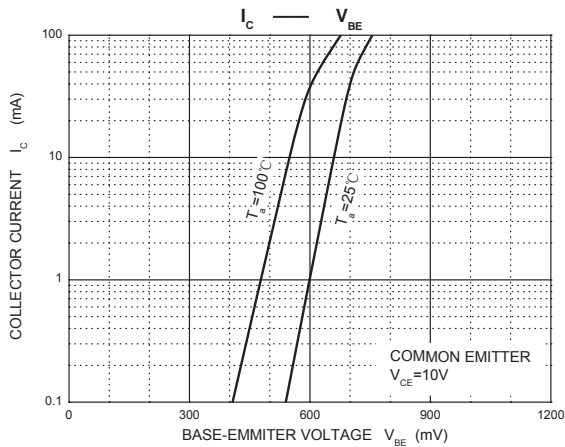
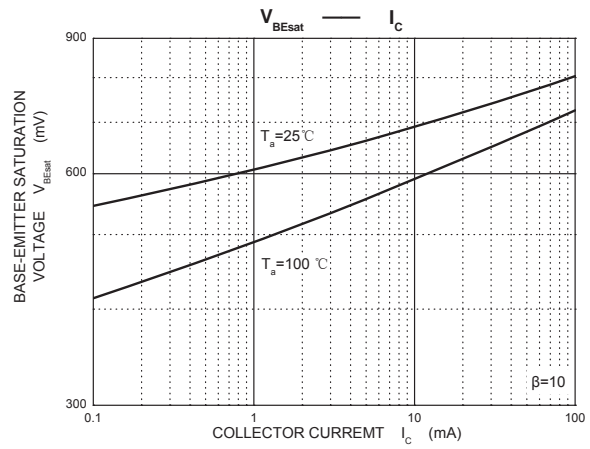
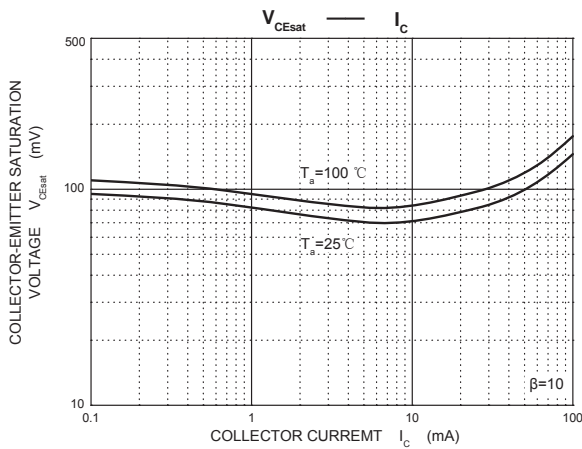
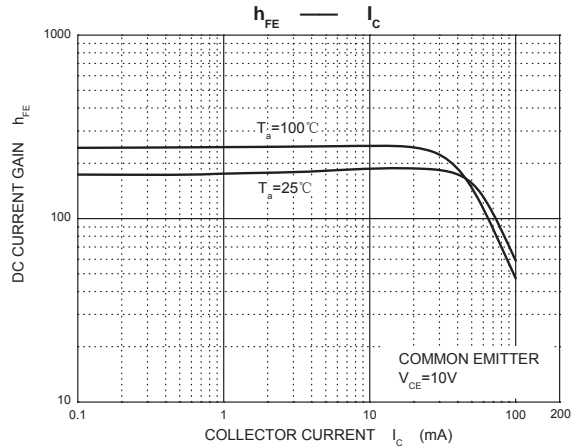
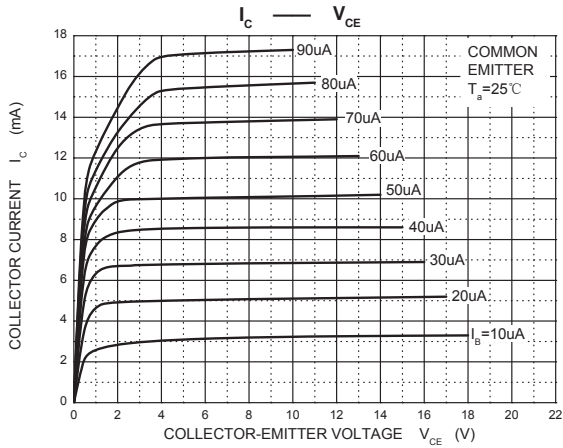

# SOT-89-3L Tape and Reel

## SOT-89-3L Embossed Carrier Tape

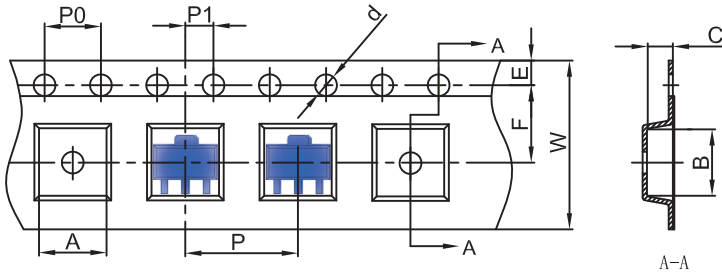

**Packaging Description:**  
 SOT-89-3L parts are shipped in tape. The carrier tape is made from a dissipative (carbon filled) polycarbonate resin. The cover tape is a multilayer film (Heat Activated Adhesive in nature) primarily composed of polyester film, adhesive layer, sealant, and anti-static sprayed agent. These reeled parts in standard option are shipped with 1,000 units per 7" or 18.0 cm diameter reel. The reels are clear in color and is made of polystyrene plastic (anti-static coated).

Dimensions are in millimeter										
Pkg type	A	B	C	d	E	F	P0	P	P1	W
SOT-89-3L	4.85	4.45	1.85	Ø1.50	1.75	5.50	4.00	8.00	2.00	12.00

## SOT-89-3L Tape Leader and Trailer

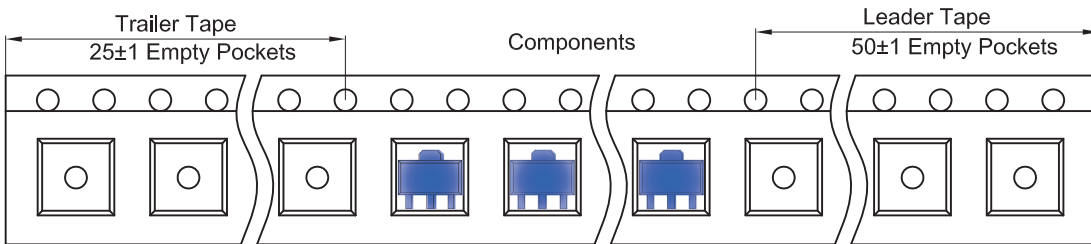

## SOT-89-3L Reel

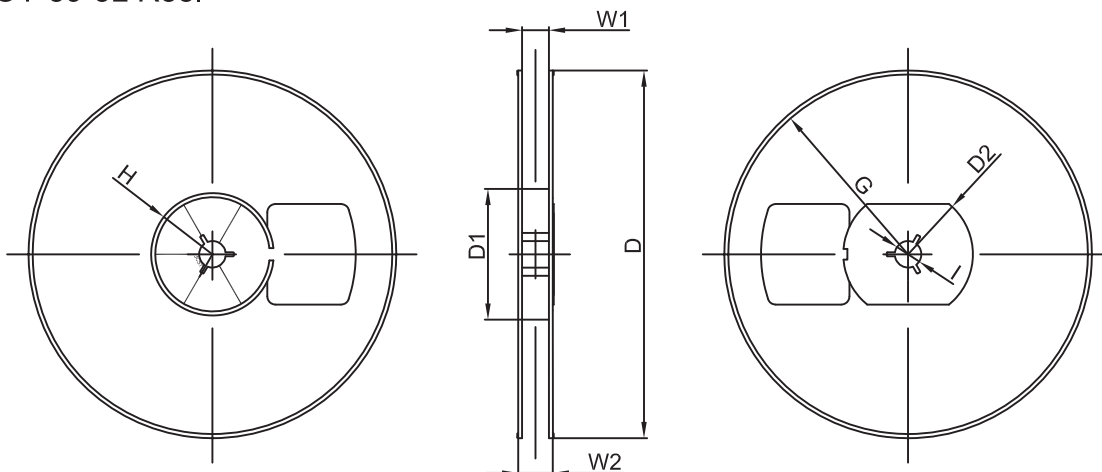

Dimensions are in millimeter								
Reel Option	D	D1	D2	G	H	I	W1	W2
7" Dia	Ø180.00	60.00	R32.00	R86.50	R30.00	Ø13.00	13.20	16.50

REEL	Reel Size	Box	Box Size(mm)	Carton	Carton Size(mm)	G.W.(kg)
1000 pcs	7 inch	10,000 pcs	203×203×195	40,000 pcs	438×438×220	